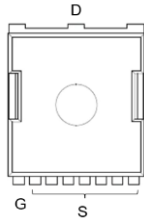

Description
135V N-CHANNEL ENHANCEMENT MODE POWER MOSFET
Features

- Device Rating $V_{DS} = 135V$, $I_D = 282A$
- $R_{DS(ON)} = 2.1m\Omega$ (typ.) @ $V_{GS} = 10V$, $I_D = 140A$
- Advanced Split Gate Trench Device Design
- RoHS Compliant & Halogen-Free
- Qualified according to JEDEC for target applications
- 100% Avalanche Test

Application

- High Performance Synchronous Rectification
- Brushless DC Motor Control
- Telecom, E-bike, Forklift, Garden tools
- Load Switch and eFuse
- Battery Protection

Package

TOLL
JFG2R6N135Q

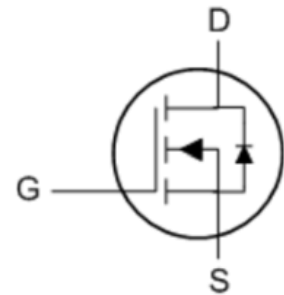
Absolute Maximum Ratings $T_J = 25^\circ C$ unless otherwise specified

Symbol	Parameter	Value	Units	
V_{DS}	Drain-Source Voltage	135	V	
V_{GS}	Gate-Source Voltage	± 20	V	
I_D	Continuous Drain Current, $V_{GS} @ 10V$ ^{note1}	$T_C = 25^\circ C$	282	A
		$T_C = 100^\circ C$	199	A
I_{DM}	Pulsed Drain Current ^{note2}	1128	A	
P_D	Power Dissipation ^{note4}	$T_C = 25^\circ C$	428	W
	Power Dissipation	$T_A = 25^\circ C$	3.75	W
E_{AS}	Single Pulsed Avalanche Energy ^{note3}	607	mJ	
T_J, T_{STG}	Operating and Storage Temperature Range	-55 to +175	$^\circ C$	

Thermal characteristics

Symbol	Parameter	Min.	Typ.	Max.	Units
$R_{\theta JC}$	Thermal Resistance, Junction to Case ^{note1}	-	0.35	-	$^\circ C/W$
$R_{\theta JA}$	Thermal Resistance, Junction-to-Ambient	-	-	40	$^\circ C/W$

Electrical Characteristics $T_J=25^{\circ}\text{C}$ unless otherwise specified

Symbol	Parameter	Test Condition	Min.	Typ.	Max.	Units
Off Characteristic						
BV_{DSS}	Drain-Source Breakdown Voltage	$V_{GS} = 0V, I_D = 250\mu A$	135	-	-	V
I_{DSS}	Drain-Source Leakage Current	$V_{DS} = 135V, V_{GS} = 0V, T_C = 25^{\circ}\text{C}$	-	-	1	μA
		$V_{DS} = 135V, V_{GS} = 0V, T_C = 125^{\circ}\text{C}$	-	-	100	μA
I_{GSS}	Gate-Source Leakage Current	$V_{DS} = 0V, V_{GS} = \pm 20V$	-100	-	100	nA
On Characteristics						
$V_{GS(th)}$	Gate Threshold Voltage	$V_{DS} = V_{GS}, I_D = 250\mu A$	2.5	-	3.5	V
$R_{DS(on)}$	Static Drain-Source On-Resistance ^{note2}	$V_{GS} = 10V, I_D = 140A$	-	2.1	2.6	m Ω
		$V_{GS} = 8V, I_D = 70A$	-	2.2	2.7	m Ω
g_{FS}	Forward Transconductance	$V_{DS} = 3V, I_D = 140A$	-	292	-	S
Dynamic Characteristics						
R_g	Gate Resistance	$f = 1.0\text{MHz}$	-	0.4	-	Ω
C_{iss}	Input Capacitance	$V_{DS} = 68V, V_{GS} = 0V, f = 1.0\text{MHz}$	-	8758	-	pF
C_{oss}	Output Capacitance		-	1319	-	pF
C_{rss}	Reverse Transfer Capacitance		-	12	-	pF
Q_g	Total Gate Charge	$V_{DS} = 68V, I_D = 70A, V_{GS} = 10V$	-	143	-	nC
Q_{gs}	Gate-Source Charge		-	42	-	nC
Q_{gd}	Gate-Drain("Miller") Charge		-	38	-	nC
Switching Characteristics						
$t_{d(on)}$	Turn-On Delay Time	$V_{DD} = 68V, I_D = 70A, R_G = 1\Omega, V_{GS} = 10V$	-	36	-	ns
t_r	Turn-On Rise Time		-	43	-	ns
$t_{d(off)}$	Turn-Off Delay Time		-	42	-	ns
t_f	Turn-Off Fall Time		-	15	-	ns
Source-Drain Diode Characteristics and Maximum Ratings						
I_S	Maximum Continuous Diode Forward Current ^{note1,5}		-	-	282	A
I_{SM}	Maximum Pulsed Diode Forward Current ^{note2,5}		-	-	1128	A
t_{rr}	Reverse Recovery Time	$V_R = 68V, I_S = 70A, V_{GS} = 0V, di/dt = 400A/\mu s$	-	56	-	ns
Q_{rr}	Reverse Recovery Charge		-	196	-	nC
V_{SD} ^{note2}	Diode Forward Voltage	$I_S = 140A, V_{GS} = 0V, T_J = 25^{\circ}\text{C}$	-	0.85	-	V
		$T_J = 125^{\circ}\text{C}$	-	0.76	-	V

Note :

- 1.The data tested by surface mounted on one inch² FR-4 board with 2OZ copper.
- 2.The data tested by pulsed, pulse width $\leq 300\mu s$, duty cycle $\leq 2\%$.
- 3.The EAS data shows Max. rating. The test condition is $L=0.5\text{mH}, I_{AS}= 51A$.
- 4.The power dissipation is limited by 150°C junction temperature.
- 5.The data is theoretically the same as I_D and I_{DM} , in real applications, should be limited by total power dissipation.

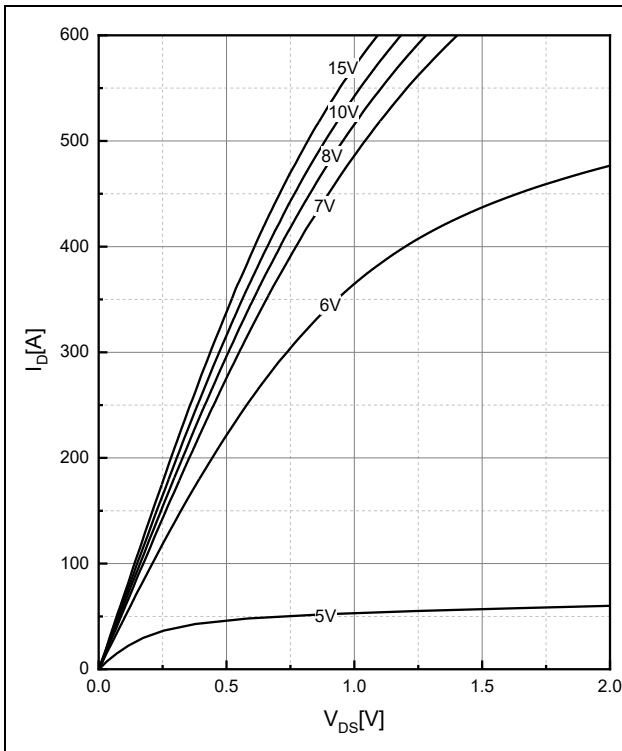
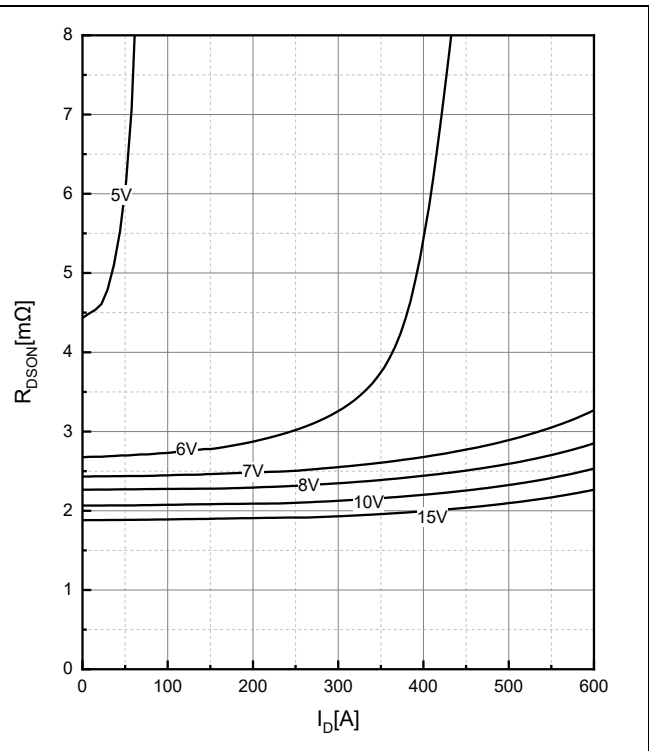
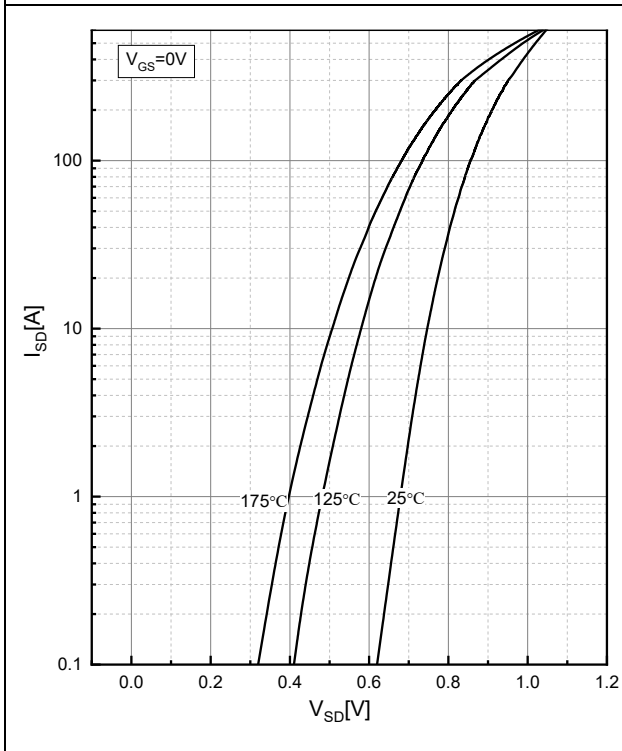
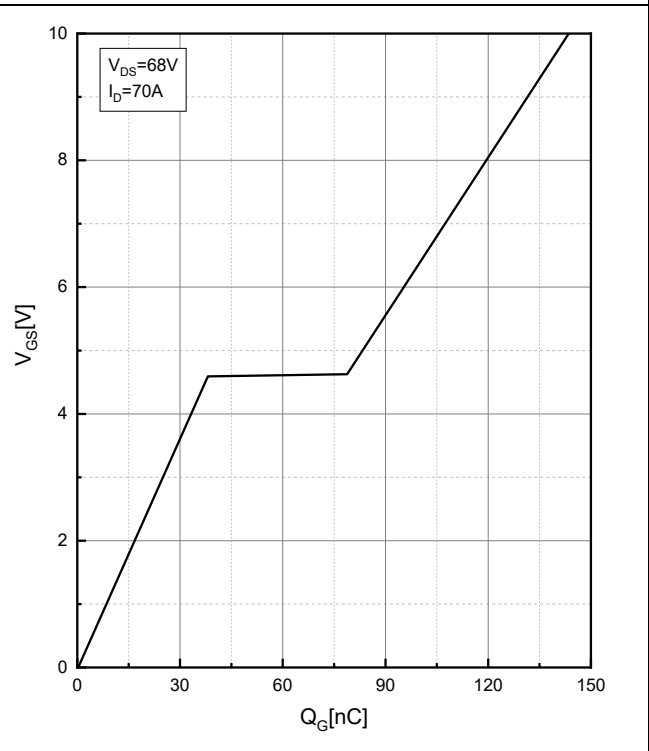
Typical Performance Characteristics

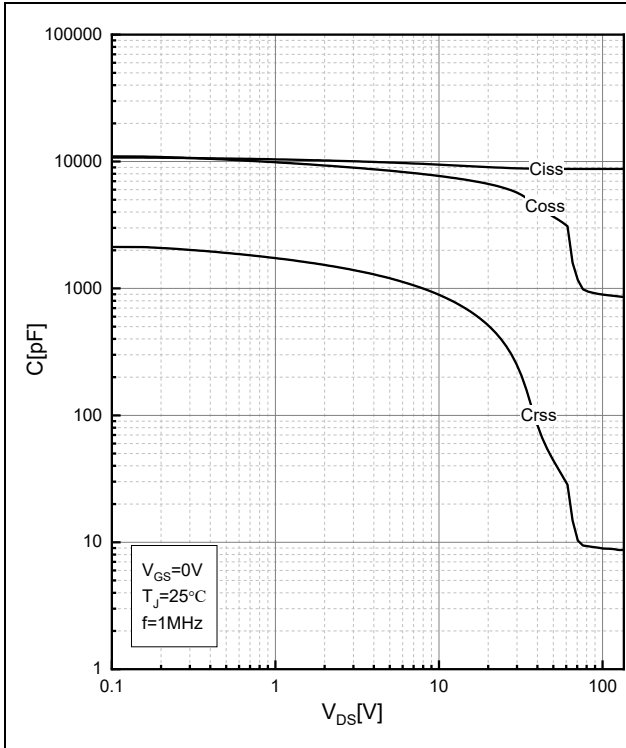
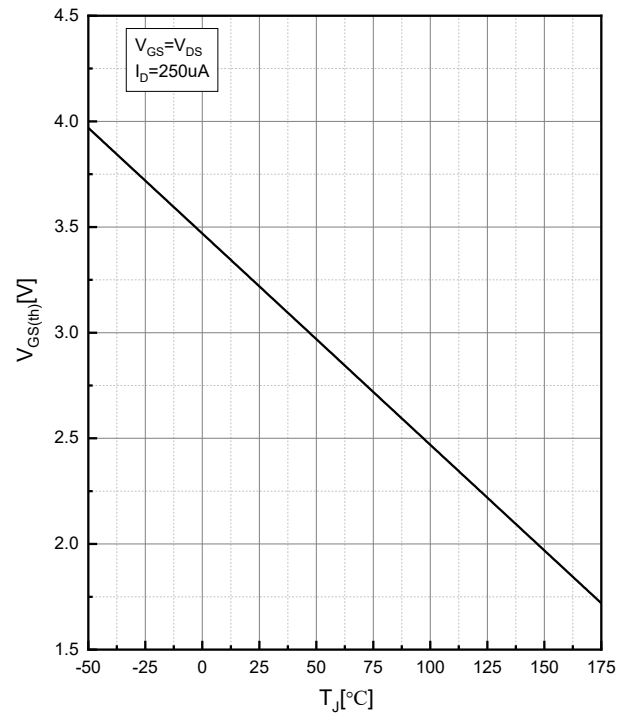
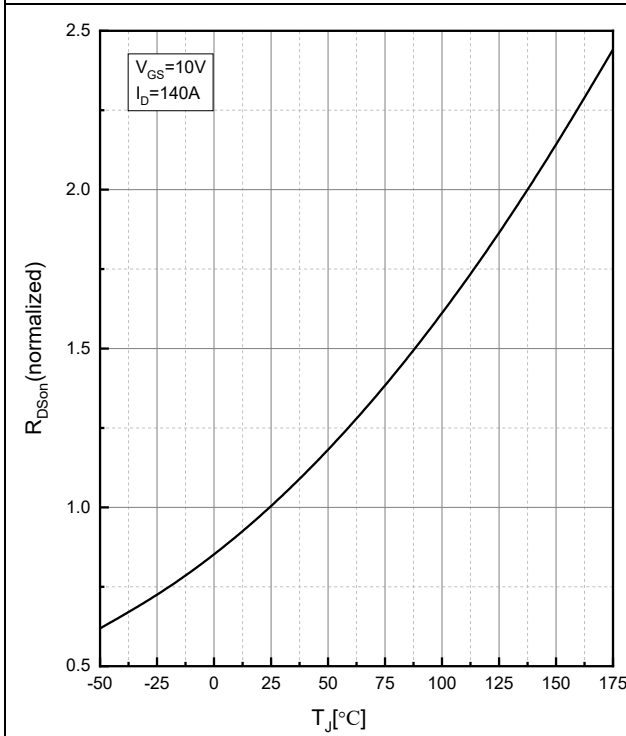
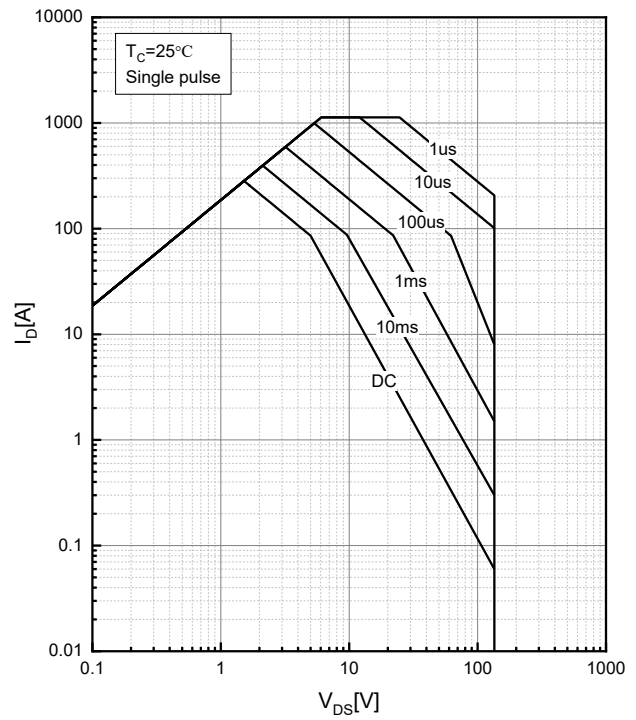
Figure 1. Output Characteristics, $T_J=25^\circ\text{C}$

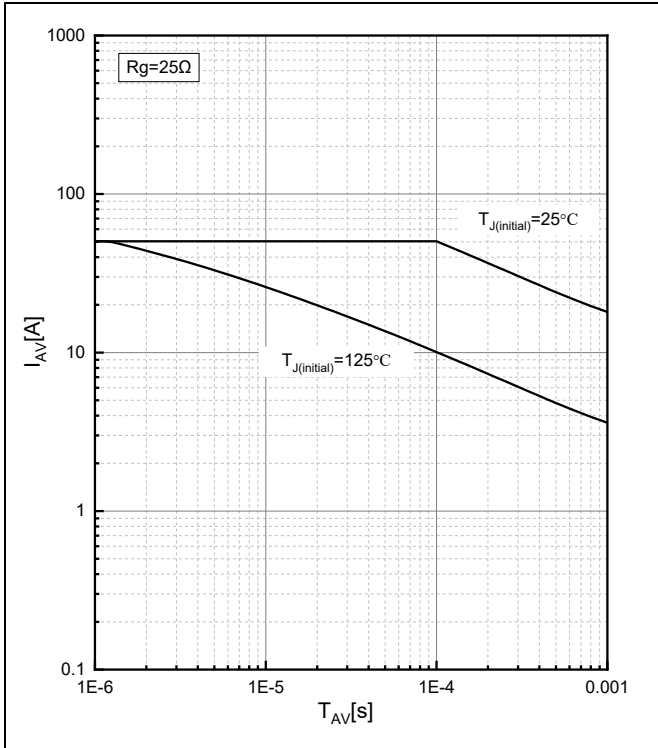
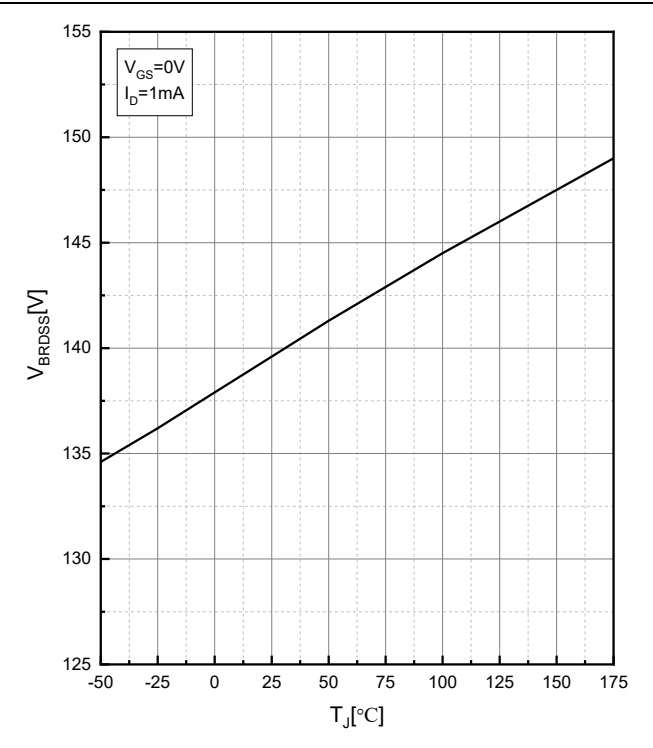
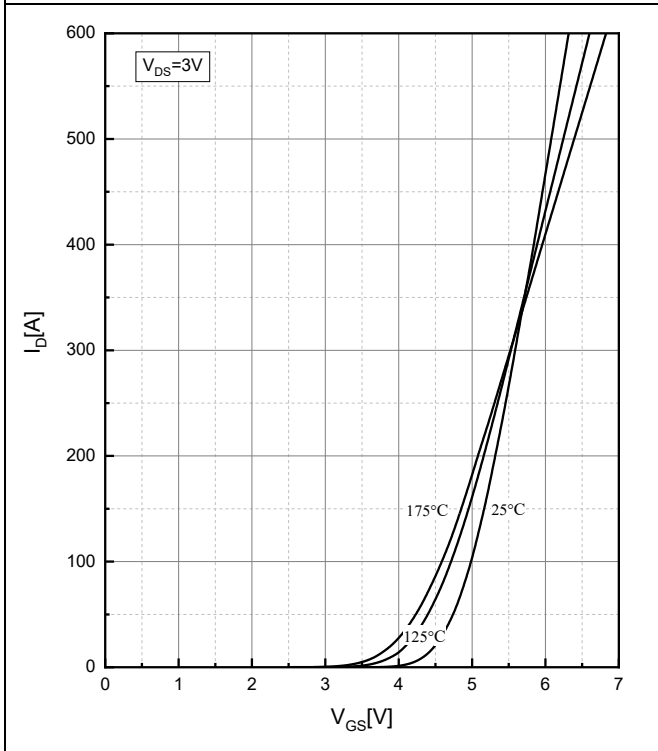
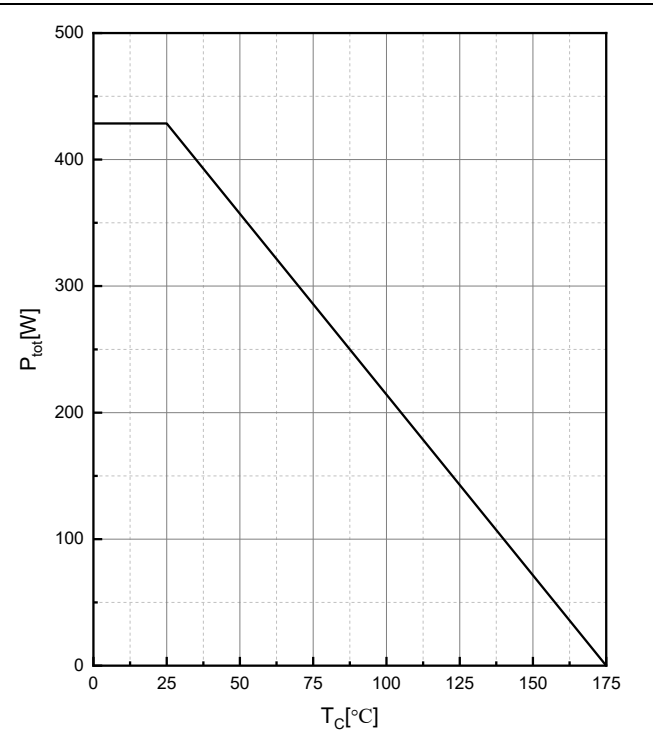
Figure 2. Drain-source on resistance , $T_J=25^\circ\text{C}$

Figure 3. Forward characteristics of body diode

Figure 4. Gate Charge Characteristics

Figure 5. Capacitance Characteristics

Figure 6. Threshold Voltage Vs. Temperature

Figure 7. Drain-source on-state resistance

Figure 8. Maximum Safe Operating Area

Figure 9. Avalanche characteristics

Figure 10. Drain-source breakdown voltage

Figure 11. Transfer characteristics

Figure 12. Power dissipation

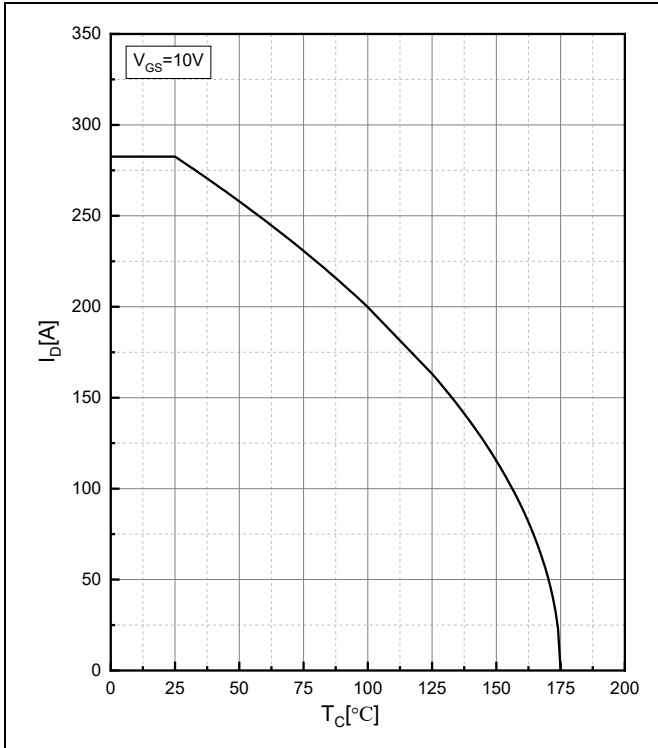

Figure 13. Drain current

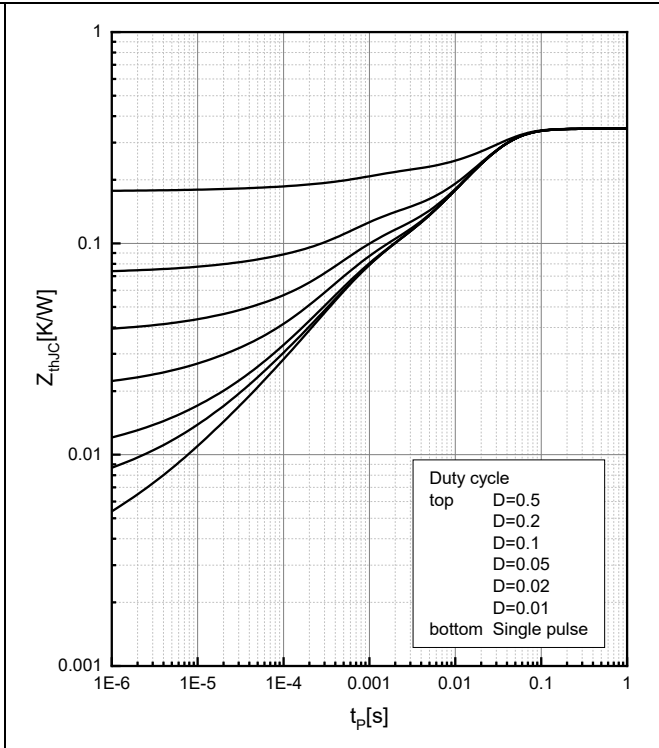

Figure 14. Effective Transient Thermal Impedance

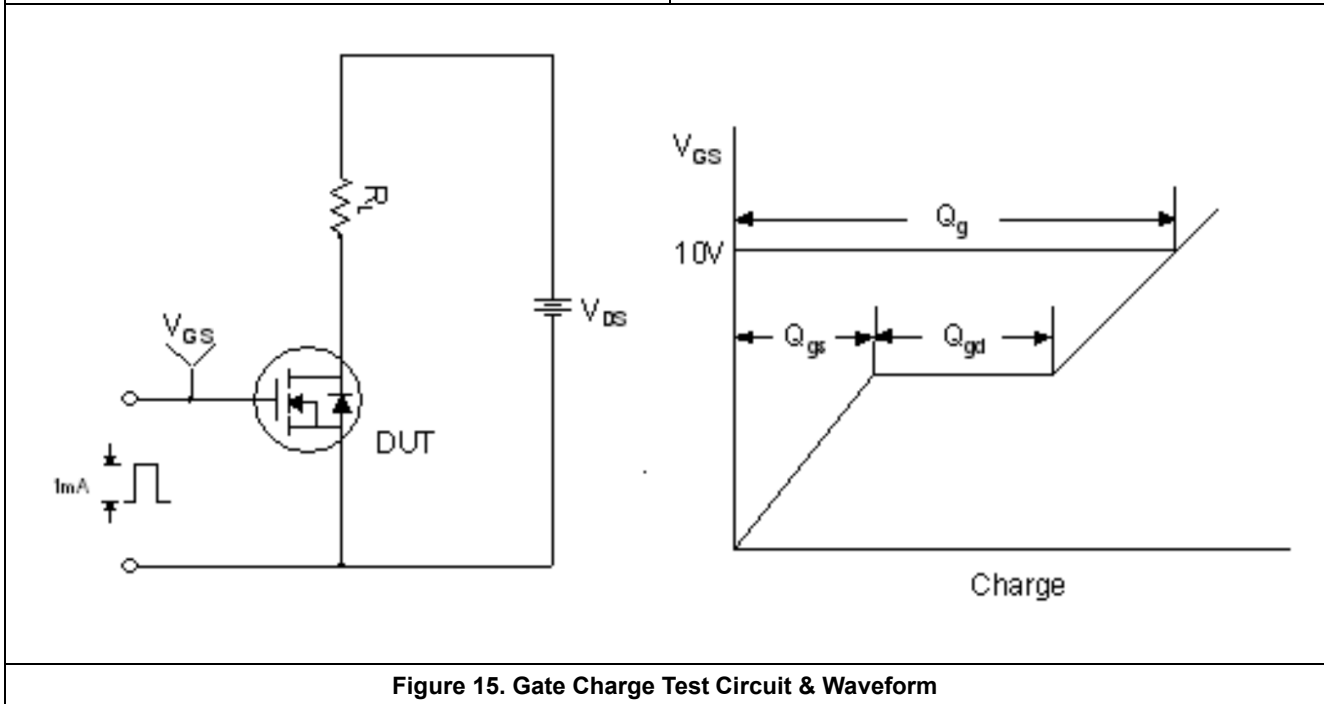

Figure 15. Gate Charge Test Circuit & Waveform

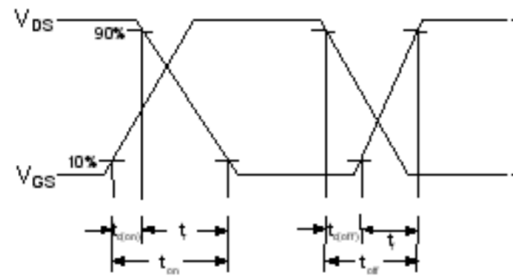
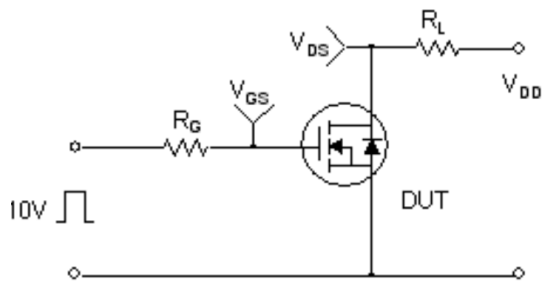

Figure 16. Resistive Switching Test Circuit & Waveforms

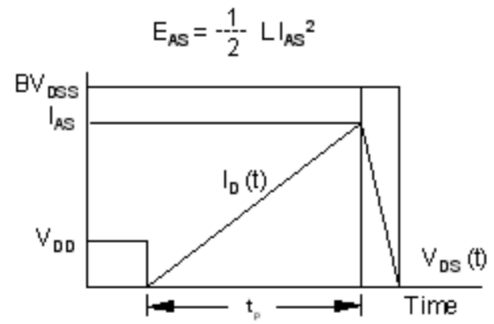
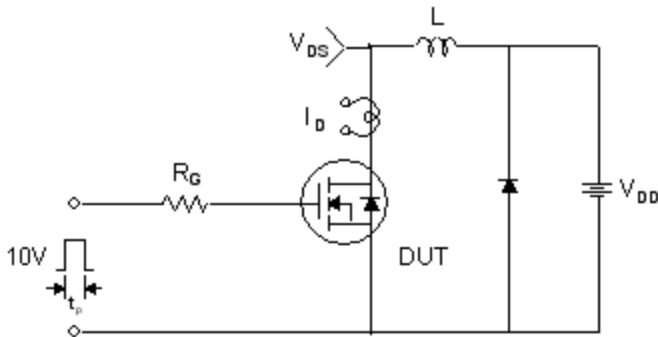

Figure 17. Unclamped Inductive Switching Test Circuit & Waveforms

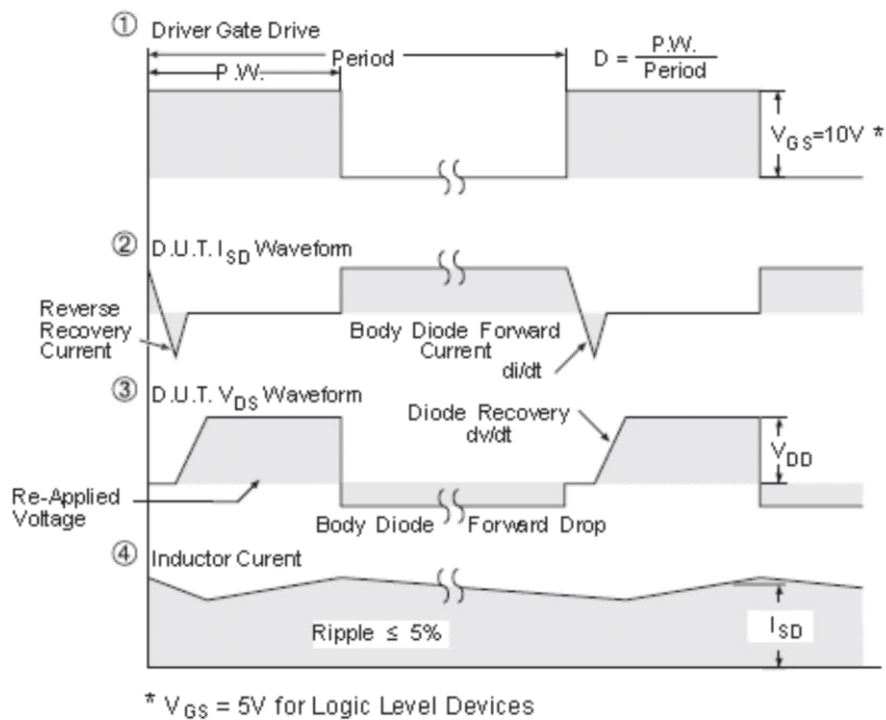
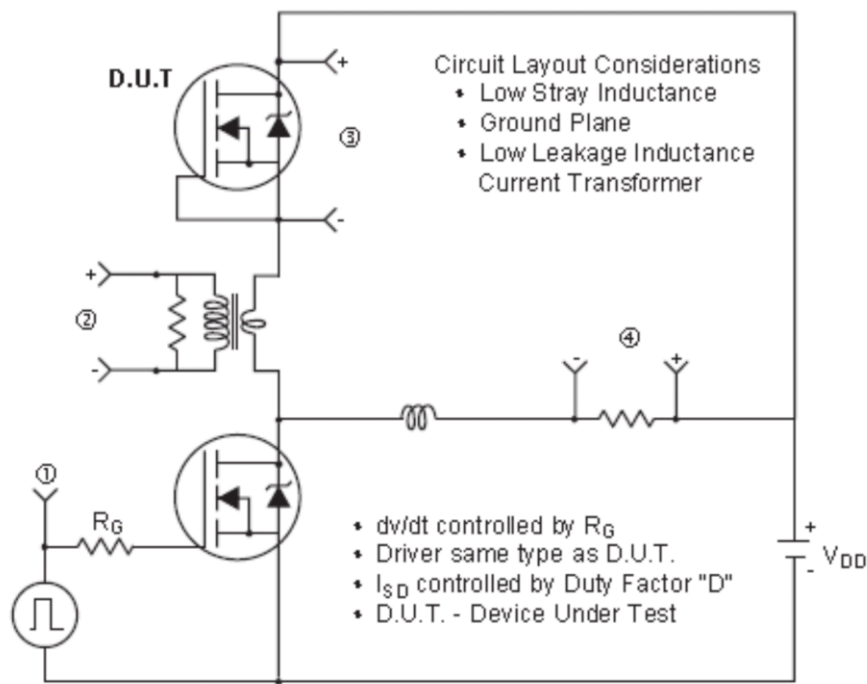
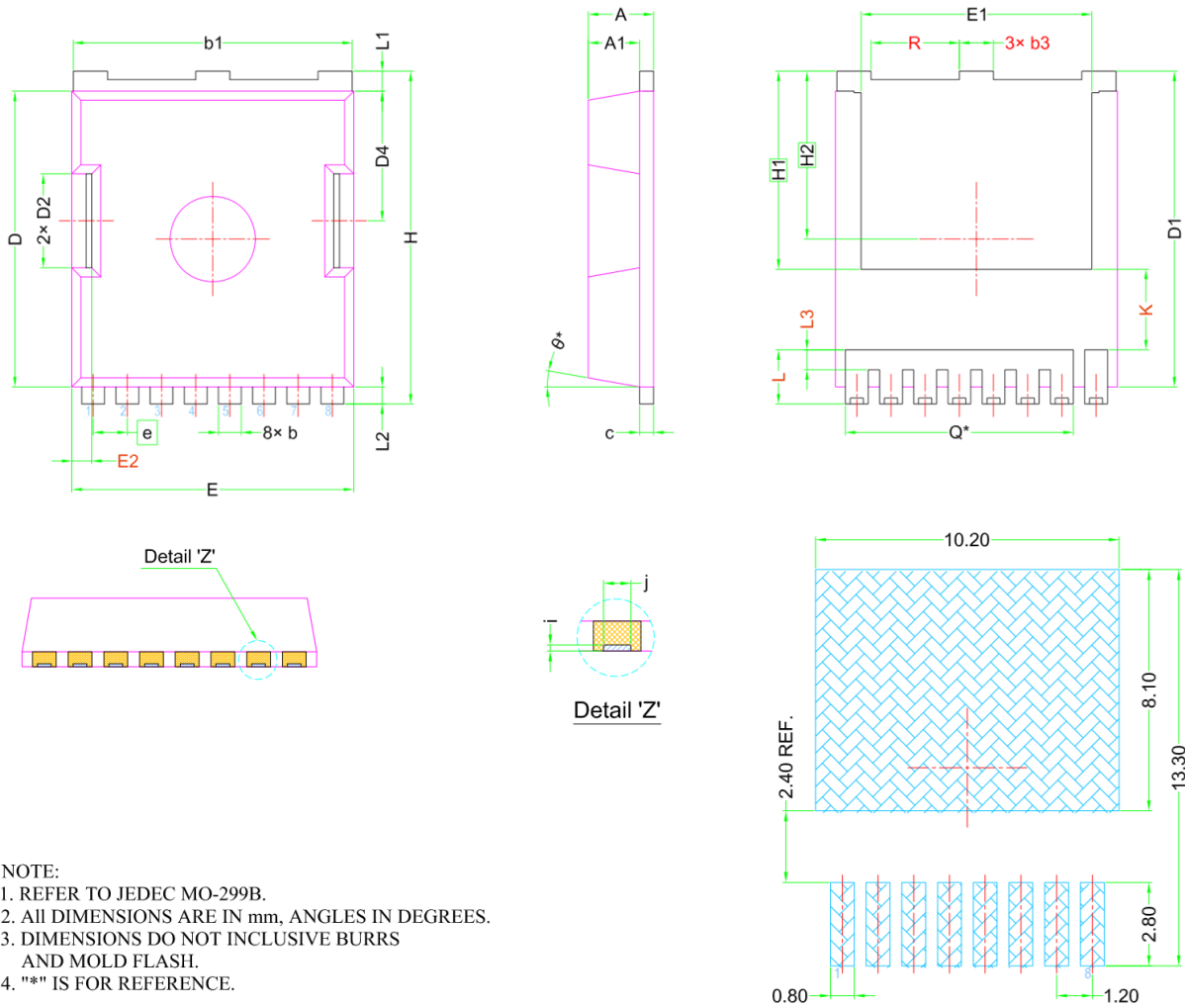

Figure 18. Peak Diode Recovery dv/dt Test Circuit & Waveforms (For N-channel)

Package outline

- NOTE:
1. REFER TO JEDEC MO-299B.
 2. All DIMENSIONS ARE IN mm, ANGLES IN DEGREES.
 3. DIMENSIONS DO NOT INCLUSIVE BURRS AND MOLD FLASH.
 4. "*" IS FOR REFERENCE.

SYMBOL	DIMENSIONS		
	MIN.	NOM.	MAX.
A	2.20	2.30	2.40
A1	1.70	1.80	1.90
b	0.70	0.80	0.90
b1	9.70	9.80	9.90
b3	1.10	1.20	1.30
c	0.40	0.50	0.60
D	10.28	10.38	10.48
D1	10.98	11.08	11.18
D2	3.20	3.30	3.40
D4	4.45	4.55	4.65
E	9.80	9.90	1 0.00
E1	8.00	8.10	8.20
E2	0.60	0.70	0.80
e	1.20 BSC		

SYMBOL	DIMENSIONS		
	MIN.	NOM.	MAX.
H	11.58	11.68	11.78
H1	6.95 BSC		
H2	5.89 BSC		
i	0.10 REF.		
j	0.46 REF.		
K	2.80 REF.		
L	1.40	1.90	2.10
L1	0.60	0.70	0.80
L2	0.50	0.60	0.70
L3	0.30	0.70	0.80
N	8		
Q	8.00 REF.		
R	3.00	3.10	3.20
θ	10° REF.		

Figure 19. TOLL Package outline

Disclaimer:

JUNSHINE does not give any representations or warranties, expressed or implied, as to the accuracy or completeness of such information and shall have no liability for the consequences of use of such information.

JUNSHINE reserves the right to make changes to information published in this document, including without limitation specifications and product descriptions, at any time and without notice. This document supersedes and replaces all information supplied prior to the publication hereof.

JUNSHINE makes no warranty, representation or guarantee regarding the suitability of the products for any particular purpose or the continuing production of any product. To the maximum extent permitted by applicable law, JUNSHINE disclaims (1) any and all liability arising out of the application or use of any product, (2) any and all liability, including without limitation special, consequential or incidental damages, and (3) any and all implied warranties, including warranties of fitness for particular purpose, non-infringement and merchantability.

JUNSHINE products, except as expressly indicated in writing, are not designed for use in medical, life-saving, or life-sustaining applications, or for any other application in which the failure of the JUNSHINE product could result in personal injury or death. Customers using or selling JUNSHINE products not expressly indicated for use in such applications do so at their own risks.

Resale of JUNSHINE products with statements different from or beyond the parameters stated by JUNSHINE for that product or service voids all express or implied warranties for the associated JUNSHINE product or service and is unfair and deceptive business practice. JUNSHINE is not responsible or liable for any such statements.

No license, express or implied, by estoppel or otherwise, to any intellectual property rights is granted by this document or by any conduct of JUNSHINE. Product names and markings noted herein may be trademarks of their respective owners.

JUNSHINE IS A FULLY OWNED SUBSIDIARY OF Wuxi XICHANWEIXIN Semiconductor Co., Ltd.